



Product Data Sheet

产品规格承认书



Product Name/产品名称: 2835 0.2W 3V 高光效产品

Document Number/文件编号: PDS-2835 0.2W 3V 高光效产品-01

Version Number/版本号: B1

Page Number/页数: Total of 18 pages/共 18 页

SDCM/色容差: standard/标准: () other/其他:

Tolerance/机差 :1. Test Machine Tolerance Yes No /有无机差
2. Based on Runlite Test Standard/按源磊测试标准

Product Application/产品应用: _____

Customer Requirement/客户要求: _____

Runlite 源磊		Customer 客户 Customer Code 客户代码: K1903023	
Prepared 制作	梁国军	Engineering 工程	
Checked 审核		Quality 品质	
Approved 批准		Approved 批准	

Notes: First/Last page need to sign and stamp, then send back to us. Thanks!
 备注: 此页和最后一页也为签核部分, 请全部签核并盖章后回传到我司, 谢谢!

SMD MID Power LED 贴片中功率 LED

P28351-WXXXXXXXXXXXX-XXXX

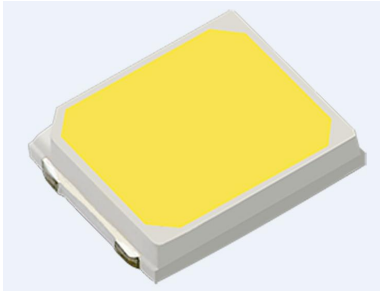

Features 特性

- PCT package / PCT 塑料
- Top view white LED / 贴片白光 LED
- High luminous intensity output / 高亮度
- Wide viewing angle / 发光角度广
- RoHS compliant / 符合 RoHS
- IEC60081 Binning / IEC60081 分 Bin 方式

Description /描述

The Runlite 2835 package has high efficacy, high Ra, low power consumption, wide viewing angle and a compact form factor. These features make the package an ideal LED for lighting applications.

源磊 2835 产品具有高光效，高显指，低功耗，发光角度广等一系列特性，这些特性使其成为照明应用的首选。

Applications 应用

- General lighting 普通照明
- Decorative Lighting 装饰照明
- Indicators 指示
- Illumination 彩灯
- Switch lights 开关灯光
- Troffer 暗灯槽

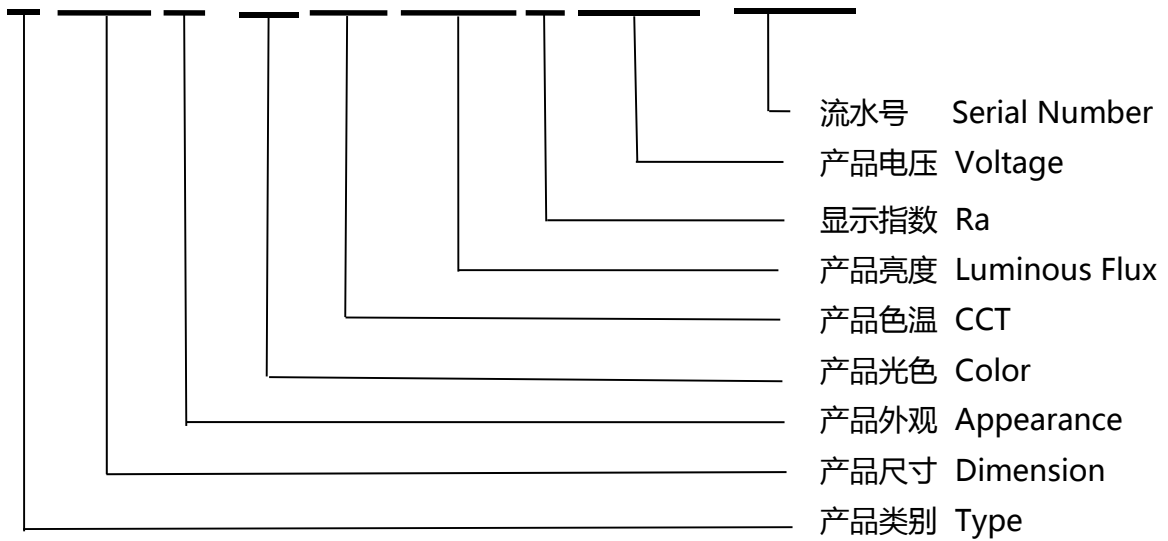
Product Number / 产品编码
P 2835 1 – W XXX XXXX X XXXX – XXXX

Table of Ra / 显色指数表格

Symbol 符号	Description 描述
A	Ra(Min.) : 没有要求
B	Ra(Min.) : 60 最小 60 显指
C	Ra(Min.) : 65 最小 65 显指
D	Ra(Min.) : 70 最小 70 显指
E	Ra(Min.) : 75 最小 75 显指
F	Ra(Min.) : 80 最小 80 显指
G	Ra(Min.) : 85 最小 85 显指
H	Ra(Min.) : 90 最小 90 显指
I	Ra(Min.) : 95 最小 95 显指

Notes / 备注:

 Tolerance of Ra: ± 2 显色指数 ± 2 .

Mass Production List / 量产清单

Product / 产品型号	Ra 显示指数	CCT(K) 色温	Φ(lm) 流明	Φ(lm) 流明	Luminous Efficiency(lm/w)
	Typ. 平均		Min. 最小	Max. 最大	Typ. 平均
P28351-W50SC8C9FB1B3-LX00	80	5000K	33	37	210
P28351-W50SC8C9FB1B3-LX01	80	5000K	33	37	215
P28351-W50SE1E2FB1B3-LX00	80	5000K	34	38	220
P28351-W50SE1E2FB1B3-LX01	80	5000K	34	38	225
P28351-W50SC9E3FB1B3-LX02	80	5000K	35	39	230

Absolute Maximum Ratings (Ts=25°C) / 极限参数 (温度=25°C)

Parameter / 参数	Symbol 符号	Rating 等级	Unit / 单位
Forward Current / 正向电流	I _F	90	mA
Peak Forward Current (Duty 1/10 @10ms) /峰值正向电流	I _{FP}	150	mA
Power Dissipation / 功耗	P _d	270	mW
Operating Temperature / 操作温度	T _{opr}	-40~+85	°C
Storage Temperature / 存储温度	T _{stg}	-40~+100	°C
Thermal Resistance (Junction / Soldering point) / 热阻	R _{th JS}	85	°C/W
Junction Temperature / 结点温度	T _j	125	°C
Anti-static Level / 抗静电	ESD	HBM(人体模式)	2000V
Soldering Temperature / 焊接温度	T _{sol}	Reflow Soldering / 回流焊: 260 °C for 10 sec.	
		Hand Soldering/手工焊: 350°C for 3 sec.	

Electro-Optical Characteristics (Ts=25°C) / 光电参数 (温度=25°C)

Parameter 参数	Symbol 符号	Min. 最小	Typ. 平均	Max. 最大	Unit 单位	Condition 条件
Luminous Flux 光通量	Φ	33	-----	39	lm	I _F =60mA
Forward Voltage 正向电压	V _F	2.6	-----	2.9	V	I _F =60mA
Ra 显色指数	Ra	-----	80	-----		I _F =60mA
Viewing Angle 发光角度	2θ ^{1/2}	-----	120	-----	deg	I _F =60mA
Reverse Current 反向电流	I _R	-----	-----	10	uA	V _R =5V

Notes/备注:

1. Tolerance of Luminous flux: ±11%. 光通量±11%.
2. Tolerance of Forward Voltage: ±0.1V. 正向电压±0.1V.
3. Tolerance of Ra: ±2 显色指数±2.
4. The products are Electro-Static discharge sensitive and must be carefully taken when handling.
本产品对静电敏感, 请操作时注意.
5. Ts point temperature is required to control within 85°C. Ts 点(Pin 脚)温度需控制在 85°C 以下.

Bin Range of Luminous Flux /光通量 Bin

P28351-W50SC8C9FB1B3-LX00

Bin Code. Bin 代码	Min. 最小	Max. 最大	Unit. 单位	Condition. 条件
C8C9	33	35	lm	I _F =60mA
	35	37		

P28351-W50SC8C9FB1B3-LX01

Bin Code. Bin 代码	Min. 最小	Max. 最大	Unit. 单位	Condition. 条件
C8C9	33	35	lm	I _F =60mA
	35	37		

P28351-W50SE1E2FB1B3-LX00

Bin Code. Bin 代码	Min. 最小	Max. 最大	Unit. 单位	Condition. 条件
E1E2	34	36	lm	I _F =60mA
	36	38		

P28351-W50SE1E2FB1B3-LX01

Bin Code. Bin 代码	Min. 最小	Max. 最大	Unit. 单位	Condition. 条件
E1E2	34	36	lm	I _F =60mA
	36	38		

P28351-W50SC9E3FB1B3-LX02

Bin Code. Bin 代码	Min. 最小	Max. 最大	Unit. 单位	Condition. 条件
C9E3	35	37	lm	I _F =60mA
	37	39		

Notes/备注:

Tolerance of Luminous flux: $\pm 11\%$, 光通量 $\pm 11\%$.

The narrowest Luminous flux bin supporting 2 continuous bins : 光通量最小接受两个连续亮度 Bin.

Bin Range of Forward Voltage / 电压 Bin

Group 群组	Bin Code Bin 代码	Min. 最小	Max. 最大	Unit 单位	Condition 条件
B1~B3	B1	2.6	2.7	V	I _F =60mA
	B2	2.7	2.8		
	B3	2.8	2.9		

Note/备注:

Tolerance of Forward Voltage: $\pm 0.1V$. 正向电压 $\pm 0.1V$.

The narrowest V_F bin supporting 3 continuous bins. 电压最小接受三个连续电压 Bin.

The C.I.E. 1931 Chromaticity Diagram C.I.E 1931 打靶图

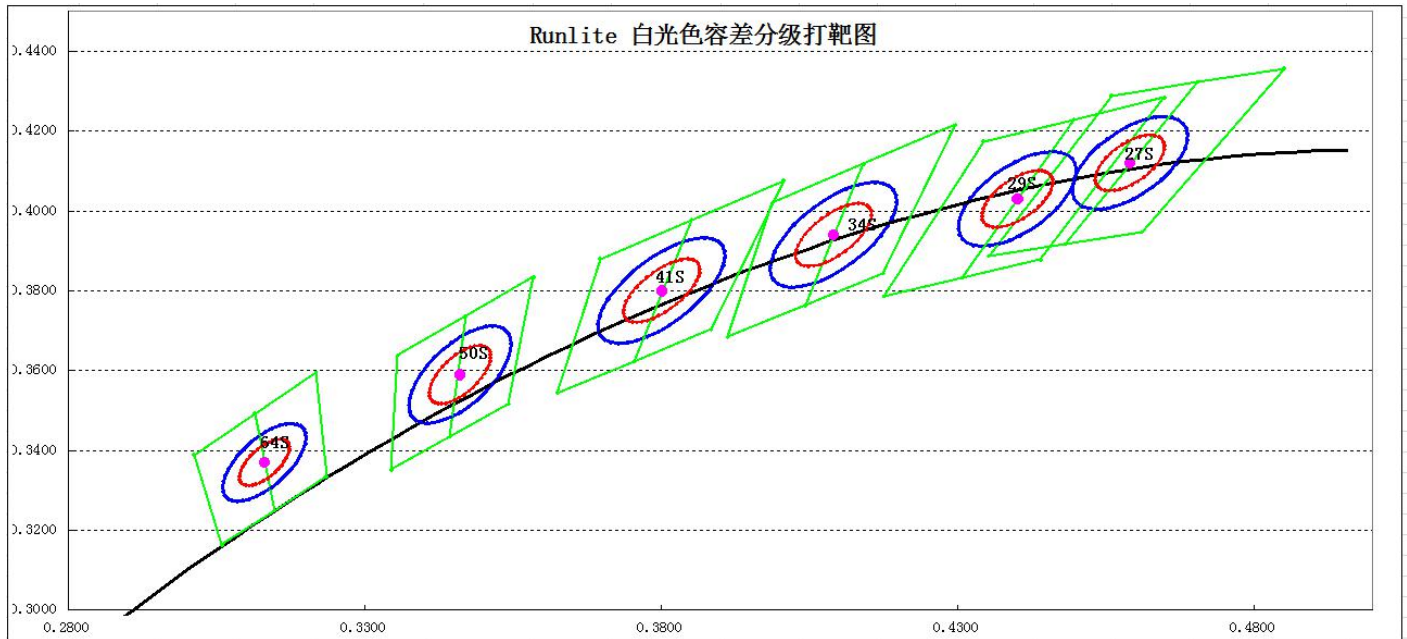

Runlite binning range based on IEC60081 color standard coordinates

Coordinates within ellipse in Red : $SDCM \leq 3$

Coordinates within ellipse in Blue : $SDCM \leq 5$

Coordinates within square in Green : $SDCM \leq 7$

Runlite 白光分级打靶图基于 IEC60081 色容差标准坐标

红色椭圆以内落点色容差 $SDCM \leq 3$ ，蓝色椭圆以内落点色容差 $SDCM \leq 5$ ，绿色方框以内落点色容差 $SDCM \leq 7$

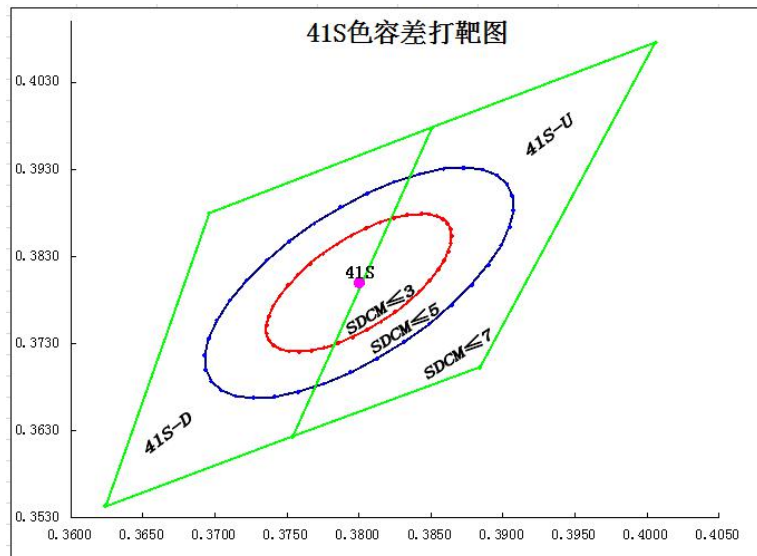

三阶 五阶 七阶对应色块示意图

Corresponding schematic diagram of Macadam 3 steps, 5 steps and 7 steps

Bin Code of Macadam 3 steps to 6 steps 麦克亚当三阶、四阶、五阶、六阶色区

Color	Steps	Center color coordinates		G11	G12	G22
		Cx	Cy			
F5000 (50S)	≤3	0.3460	0.3590	56.0	-25.0	28.0
	≤4					
	≤5					
	≤6					

Bin Range of Chromaticity Coordinates 色坐标范围

CCT	Bin Code	CIE-X	CIE-Y	Bin Code	CIE-X	CIE-Y
50S 5000K	50S-D	0.3344	0.3352	50S-U	0.3443	0.3434
		0.3355	0.3639		0.3470	0.3737
		0.3470	0.3737		0.3584	0.3834
		0.3443	0.3434		0.3542	0.3516
		0.3344	0.3352		0.3443	0.3434

Note/备注:

- The above data is based on driving current of 60mA. 上述数据基于 60mA 的驱动电流。
- Tolerance of Chromaticity Coordinates: ±0.01. 色度坐标公差: ±0.01

Recommend Reflow Soldering Profile 回流焊接曲线图

Lead Tin Solder 有铅焊接

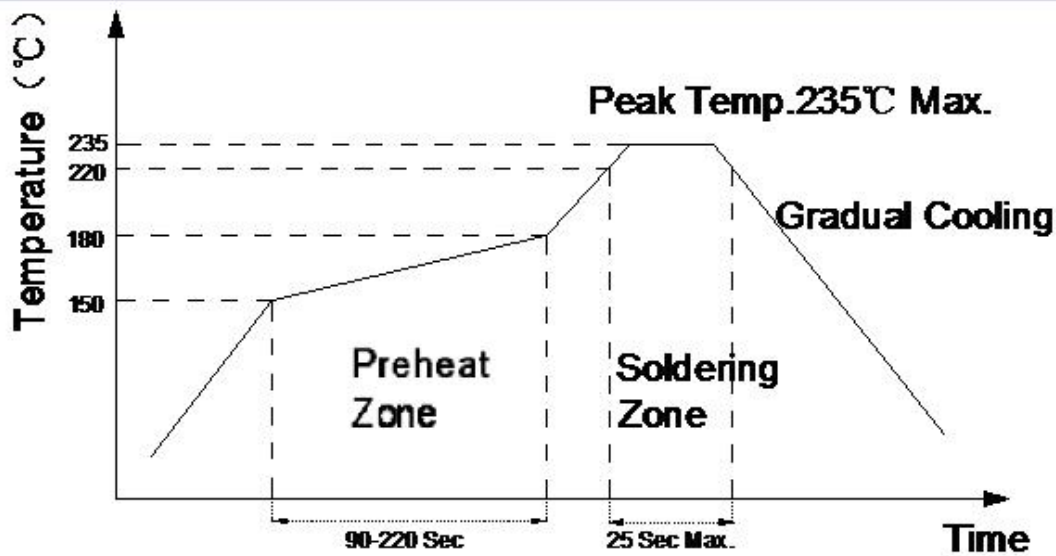

Lead Free Solder 无铅焊接

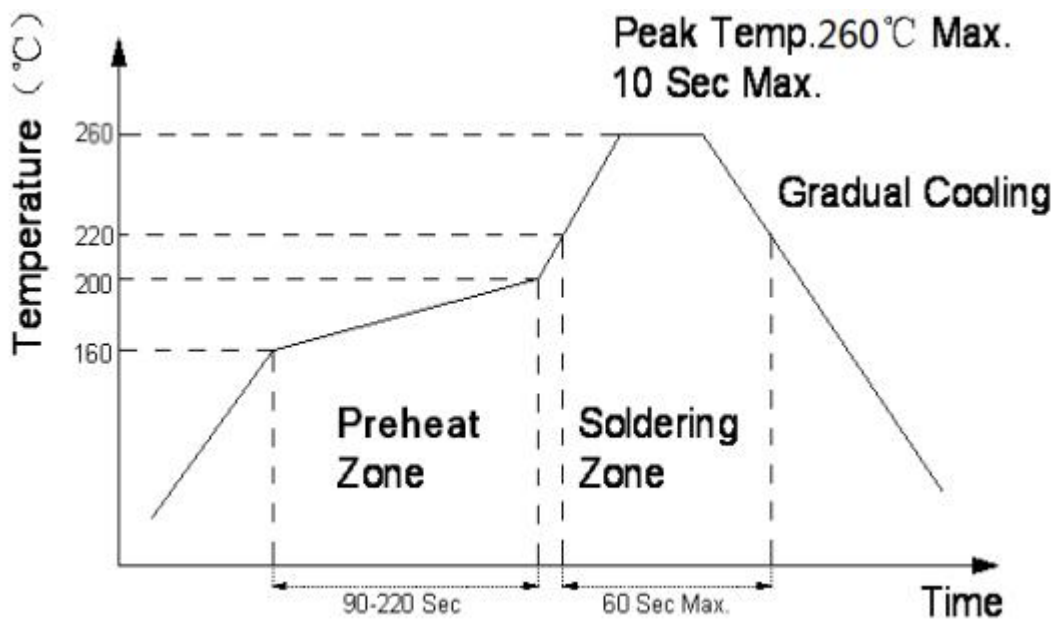

NOTES :

1. We recommend the reflow temperature $255^{\circ}\text{C} \pm 5^{\circ}\text{C}$.
2. Do not apply stress to the resin surface while it is exposed to high temperature.
3. Number of reflow shall be 1 time only.

注意：

- 1.我们建议的回流焊温度为 $255^{\circ}\text{C} \pm 5^{\circ}\text{C}$ 。
- 2.当产品在处在高温状态中时不要对其硅胶施加压力。
- 3.回流焊的次数应小于两次。

Spectrum Distribution 光谱分布图

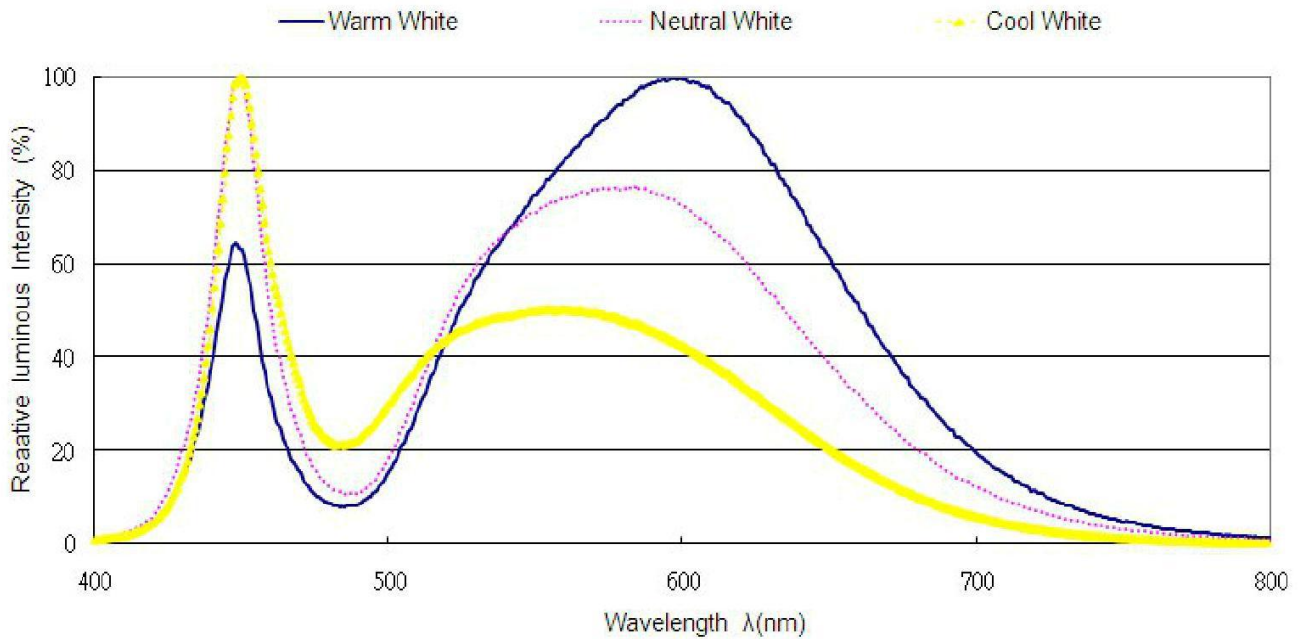

Typical Spectral Distribution 发光角度图 (极坐标)

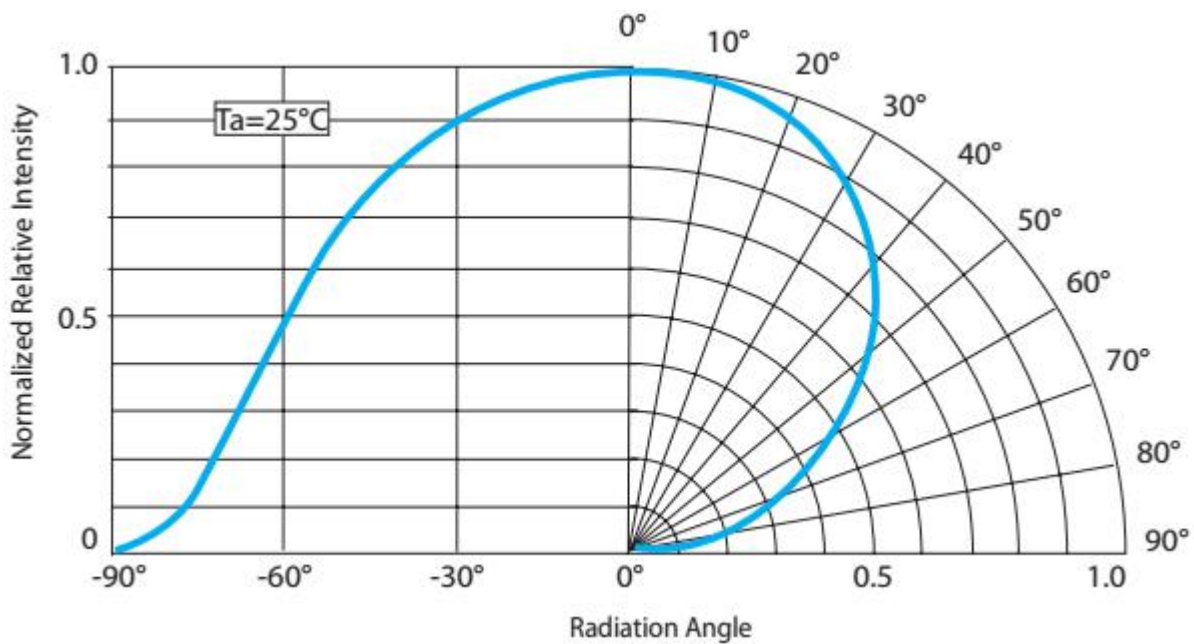

Typical Electro-Optical Characteristics Curves 典型光电特性曲线图

Forward Current VS Forward Voltage
 电流与电压关系曲线图

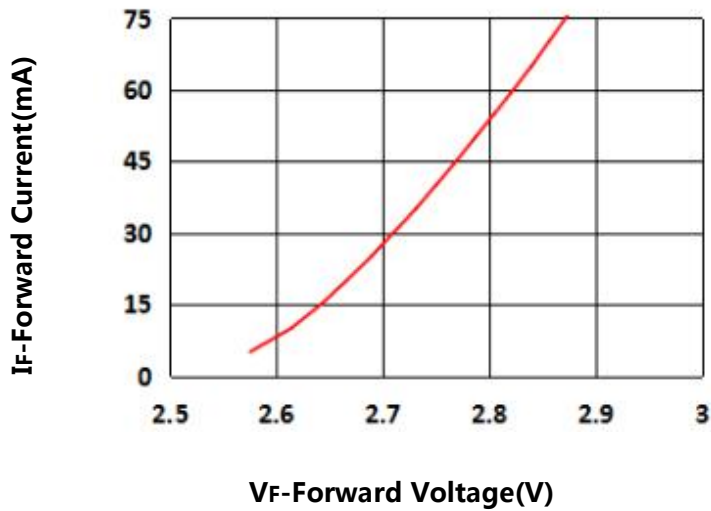

Relative Luminous Flux VS Forward Current
 亮度与电流关系曲线图

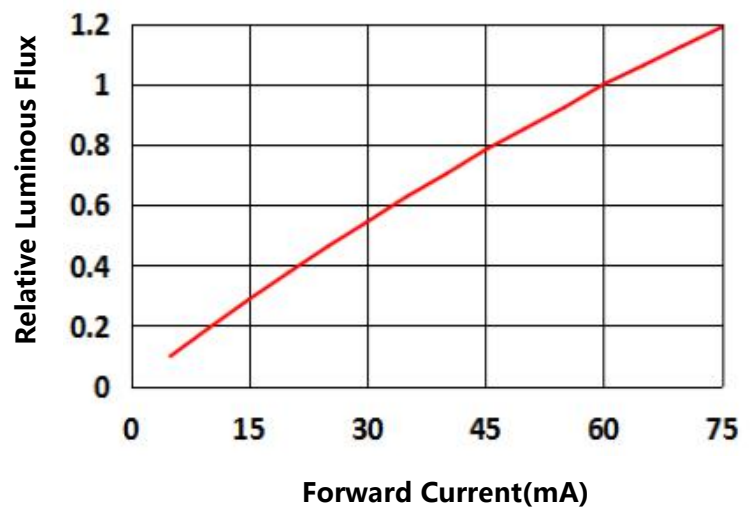

Relative Luminous Flux VS Junction Temperature
 亮度与结温关系曲线图

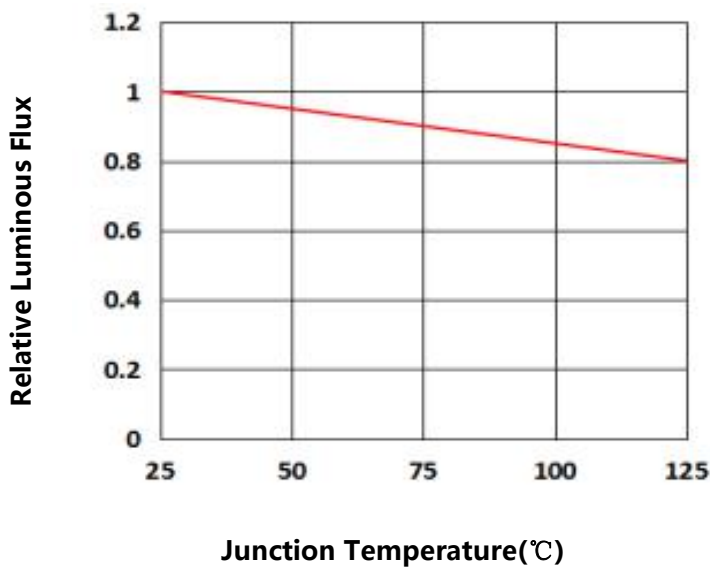

Forward Current VS Soldering Temperature
 电流与温度关系曲线图

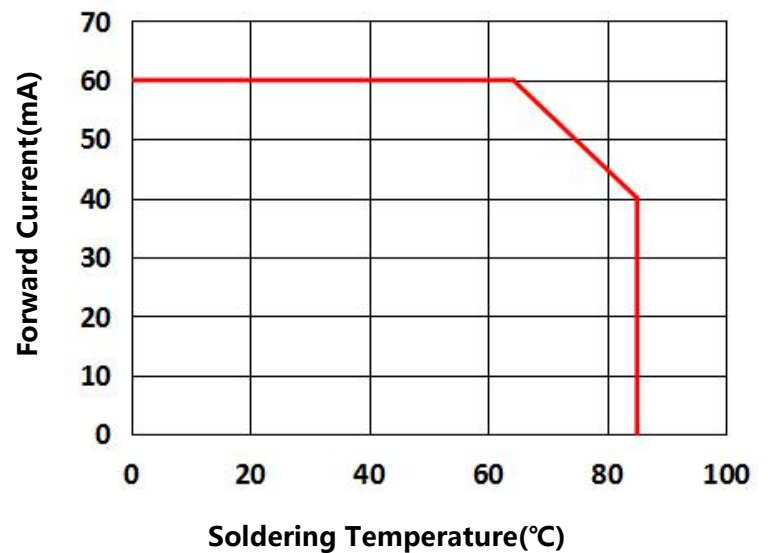

Package Dimension 封装尺寸

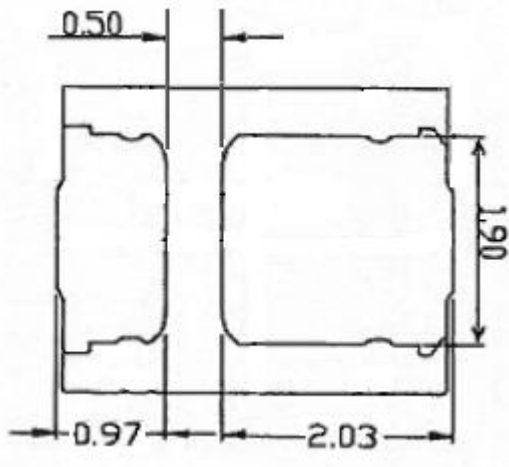
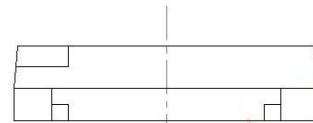
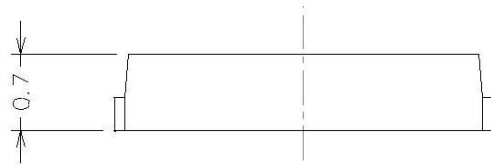
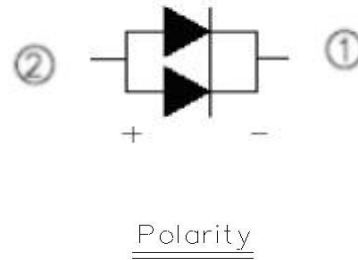
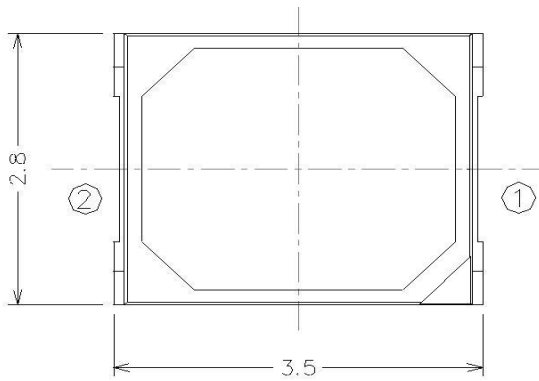

Recommended Soldering Pattern (建议焊盘尺寸图)

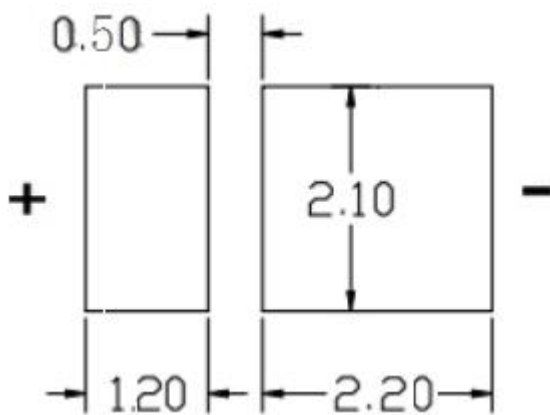

Note:

Tolerance unless mentioned is $\pm 0.15\text{mm}$; unit : mm.

若无特别标注，图中尺寸公差为 $\pm 0.15\text{mm}$ ，单位：mm.

Moisture Resistant Packing / 防潮包装

Label Explanation / 标签解析

 深圳市源磊科技有限公司 Shenzhen Runlite Technology Co., Ltd 让光更有温度!			
产品型号		BIN 号	
品名描述		色容差(Δ)	
批号		功率(W)	
客户订单号		驱动电流(mA)	
客户料号		电压(V)	
数量(PCS)		日期	
显色指数(≥)		 0000	
色温/波长 (K/nm)			
光通量/亮度 (LM/mcd)			

Reel Dimensions 卷轴尺寸

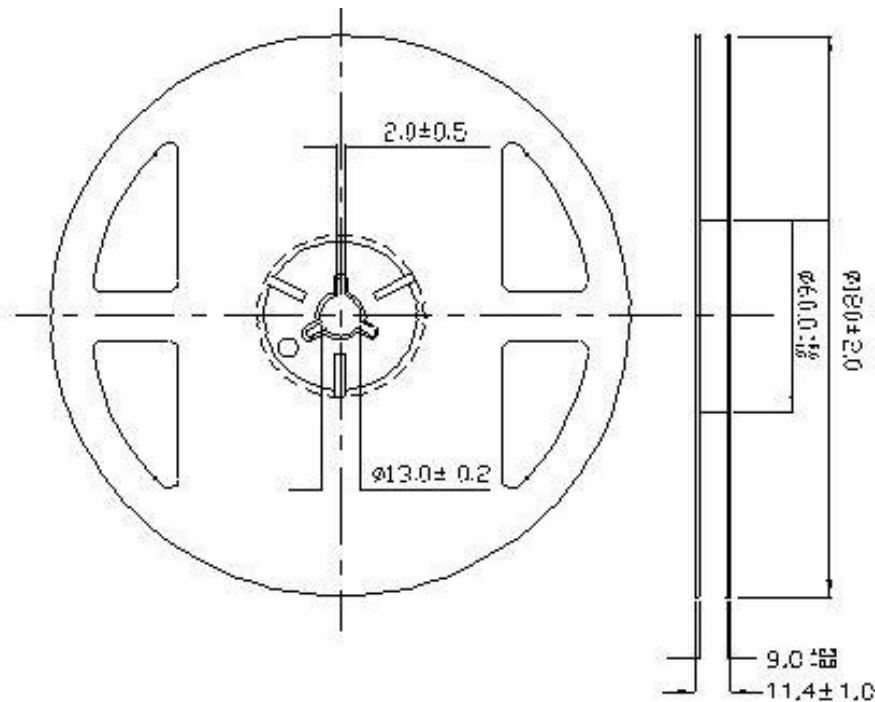

Note:

Tolerance unless mentioned ± 0.1 mm, unit : mm.

若无特别标注,图中尺寸公差为 ± 0.1 mm,单位 : mm.

Carrier Tape Specification: Quantity 4000 pcs per reel

卷盘规格：编带 4000PCS/卷

Progressive direction 使用方向

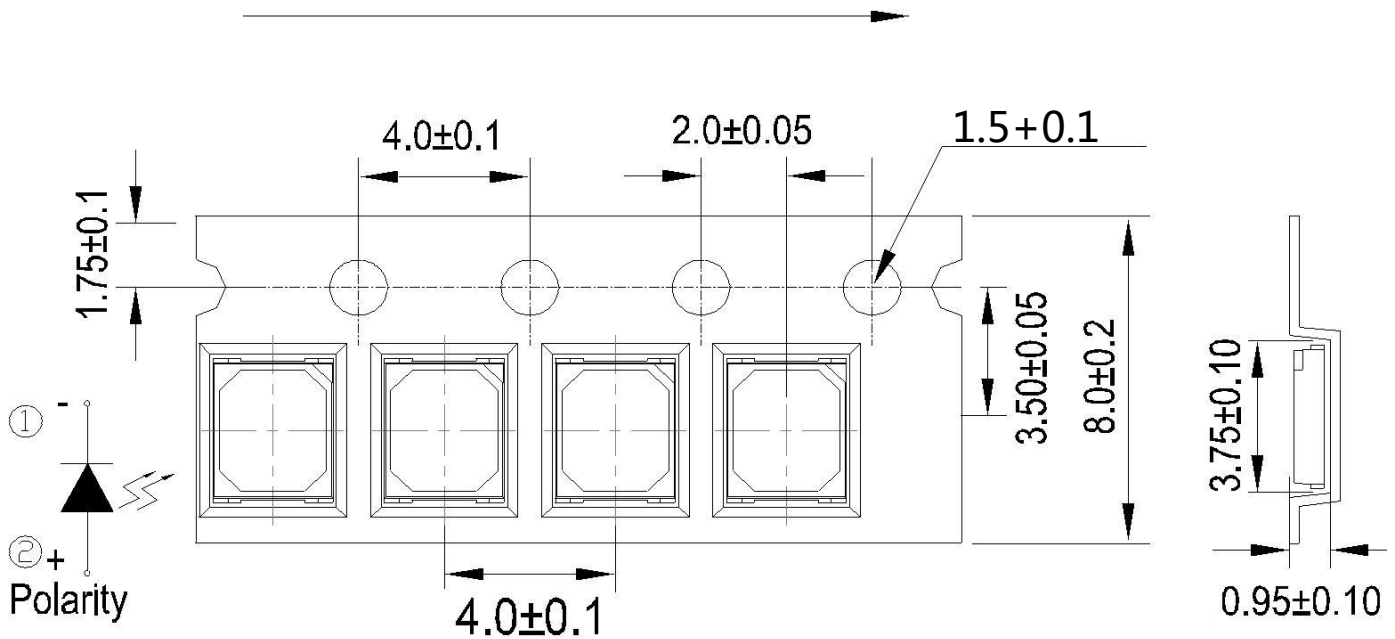

Note:

1. Tolerance unless mentioned is $\pm 0.1\text{mm}$; unit : mm.

若无特别标注,图中尺寸公差为 $\pm 0.1\text{mm}$.

Moisture Resistant Packing Process/ 包装步骤



Reliability Test Items and Conditions/信赖性测试项目条件

The products shall be satisfied tests as listed below. 产品应满足以下测试要求。

Confidence level : 90%.

LTPD : 10%.

Test Item 测试项目	Test Conditions 测试条件	Duration/Cycle 持续周期	Quantity 数量	Ac/Re 接收/拒收
Thermal Shock 冷热冲击	-40°C 15min ⇕ 10sec 100°C 15min	100 times 循环 100 次	22PCS	0/1
High Temperature Storage 高温储存	Ta=100°C	1000 hours 1000 小时	22PCS	0/1
Humidity Heat Storage 高温高湿	Ta=85°C RH=85%	168 hours 168 小时	22PCS	0/1
Low Temperature Storage 低温储存	Ta=-40°C	1000 hours 1000 小时	22PCS	0/1
Room Temperature Test 常温老化	Ta=25°C If=60mA	1000 hours 1000 小时	22PCS	0/1

SMD LED Precautions for use

SMD 型 LED 使用注意事项

Thanks for using LED products of Shenzhen Runlite Technology Co.,Ltd., in order to enhance your understanding of the characteristics of our products, and avoid unnecessary damage of the product that due to human factors. We are providing the corresponding instructions for handling the LEDs. The LEDs actual performance will variate because of the different application design, mode of operation and conditions of use. This Instructions can't cover all questions which may encounter during customer use process, We sincerely apologize for any inconvenience this may cause.

感谢您使用深圳市源磊科技有限公司的系列 LED 产品，为增进您对我公司产品特性的了解，也为方便您快速掌握产品的基本操作。为尽量减少或避免因人为等因素造成不必要的产品损坏，使其能够更好的为您的生产服务，特针对使用过程中的一些规范使用作相应说明，同时即使是同一规格 LED，在实际应用领域其可靠性与整体系统设计水平、作业方式、使用条件均相关。本使用说明不可能涵盖客户使用过程中可能碰到的所有问题，由此带来的不便，敬请谅解！

1、Declaration :

In order to confirm if it is right to the application , pre-study is necessary before use the product. This product presentation does not guarantee any patent. Relate to imports and exports LED product Legal liability should be responsible by customer, so please verify relevant provision about the LED product in your target market. We may change specification from time to time because of product continuous development, without prior notification or public announcement. An agreement of formal product specification is required which prior to mass production.

1、产品申明：

使用本产品之前，请贵司务必预先进行测试，以便确认是否适合使用目的。产品介绍的用途并不保证不抵触任何专利，有关 LED 产品的进出口法律责任应由客户担负，请预先查清每一国家或地区的有关规定。产品可能会因性能提高或规格参数改变等缘故，恕不经预告更改。我们要求量产前签订正式的产品规格书。

2、Before use :

We suggest that the same parameter products should be used together , such as BIN coordinate , Vf and luminous flux etc.

2、物料确认：

投料的 LED BIN 等级是否吻合，如 VF、CIE BIN、亮度等是否属同一等级，同一等级的应在一起使用。若不是同一等级的 LED 应用在同一物件上，应先评估其适用性，（若不同 VF 或 CIE BIN 投在一起可能会发生亮度上或颜色上的差异）

3、Package and Storage :

3.1、To avoid the moisture absorb, we recommend keeping LEDs in a dry box (or desiccator) with a desiccant . The recommended storage conditions are 5 to 30°C, 50% maximum humidity. You have to dehumidify LEDs if stored for more than 3 months, the re-bake condition with 70°C/24 hours.

3.2、Precaution of handling

The LED is SMD package, not recommended using solder dipping process, package quality may affected and the light intensity to drop.

a. Soldering should be done right after open the packing within 12 hours.

b. Remain LEDs are to seal in packing and store in 5 ~ 40°C, ≦30%RH.

c. Dehumidify LEDs at 70°C/24 hours if opened packing and exposed to the air for 24 hours or desiccant changes color from blue to pink.

3.3、The solder pad/metal surface is Ag-plated and can be damaged easily by corrosive substances. Need to keep LEDs away from corrosive substance and environment, in order to avoid color fade, soldering issue, or may result in failure of LED. Also, high temperature and high humidity environment will affect the LEDs performance and quality.

3、包装储存：

3.1、开包装前避免湿气进入 LED 内部，建议 SMD 系列 LED 存放在内置干燥剂的干燥柜中，储存环境为温度 5-30°C，湿度不超过 50%。若存储时间超过 3 个月，LED 需要重新除潮（70°C/24 小时以上）。

3.2、开包装后的预防措施

LED 是表面贴装件，当 LED 进行焊接时，可能会发生 LED 内部分离，其发光效率受到影响而导致亮度下降或发光颜色变异。

以下是需注意的事项：

- a、开包装后应尽快完成焊接（12小时内）。
- b、余料请密封或放置在 5 ~ 40°C、湿度不超过 30%的环境中。
- c、如果开包装超过 24H 或干燥剂由蓝色变为粉红色，LED 需要重新除潮（70°C/24 小时以上）。

3.3、LED 电极和支架是由镀银的铜合金组成，外表银层易受到腐蚀性气体影响，请避免接触腐蚀的环境造成 LED 变色、以免产生 LED 的焊接性变差或者影响光电性能。请避免环境温湿度的骤变，尤其是高湿环境下易产生水汽凝结。

4、Heat Generation:

4.1、Thermal design of the end product is of very important. Please consider the heat generation of the LED when design the system. The overall operation temperature will increasing subject to input power, the thermal resistance of the circuit board and density of LEDs and other components placed on the board. It is necessary to avoid intense heat generation and operate within the maximum ratings given.

4.2、The operating current is decided by considering the ambient temperature and maximum junction of LEDs.

4、热沉：

4.1、LED 应用终端产品应考虑散热设计，LED 功率温升系数由 LED 在线路板中的排布密度、热阻、和环境温度来决定。设计时 LED 产生的热量不超过其最大极限值（参考 LED Tj 结温），和其他电子元器件一样，有必要考虑避开发热元件的设计。

4.2、LED 发光工作时，请考虑其工作电流应该由其最大工作结温决定。

5、Recommended soldering:

5.1、Please refer to reflow recommendation and not suitable for the solder dipping process.

5.2、Reflow soldering should not be done more than two times.

5.3、Components should not be mounted on warped direction of PCB. Please avoid rapid cooling after soldering. Any mechanical force or any excess vibration shall not be accepted to apply during cooling process. After soldering, do not warp the PCB.

5.4、Repairing should not be done after the LEDs have been soldered. When repairing is unavoidable, a double-head/suitable soldering iron is suggested. It should be confirmed before hand whether the characteristics of the LEDs will not be damaged by repairing.

5、焊接条件：

5.1、产品是否适合回流焊制程请参考对应产品的规格书。源磊不对浸润式的焊接方式进行质保。

5.2、回流焊接温度及时间请参照对应产品规格书。LED 不宜进行两次或两次以上的回流焊接。

5.3、不建议将 LED 贴装在弯曲的线路板上。焊接时避免快速冷却，在 LED 焊接冷却过程中避免任何形式的机械力或过度的震动，焊接后，不要弯曲线路板。

5.4、完成焊接的 LED 不宜进行返修作业。如不可避免，采用双头烙铁，但事先应确认返修是否会对 LED 的特性产生破坏。

6、Handling of Electrostatic Discharge：

These products are sensitive to electrostatic discharge. Please to provide low level electrostatic discharge environment for assembled LEDs, wearing of a wristband or anti-static gloves when handling this product. All devices, equipment and machinery must be properly grounded. It is recommended that precautions be taken against surge voltage to the equipment. When inspecting the final products in which LEDs were assembled, it is recommended to check whether the assembled LEDs are damaged by static electricity or not. It is easy to find ESD-damaged LEDs by a light-on test @1mA/dice (reference).

6、静电防护：

LED 是静电敏感电子元器件，应采取各种措施避免静电，诸如在使用过程中戴静电手环或防静电手套。所有的装置、设备仪器应适当的接地。建议在贴装 LED 时预防机器设备的浪，建议对组装后的 LED 产品进行测试检查 LED 是否受到静电的破坏，白光或蓝光 LED 确认方法为（参考）：1mA 或 2.5V/单颗芯片不能点亮或同等条件下亮度较其他 LED 明显偏暗为缺陷品。

7、Cleaning：

Runlite suggests using isopropyl alcohol for cleaning if necessary. In case other solvents are used, it must be assured that these solvents do not dissolve the package or resin. Ultrasonic cleaning is not

recommended. Ultrasonic cleaning may cause damage to the LED. If have to do that, please pre-test the new cleaning method for preventing affect the LEDs quality.

7、清洁清洗：

建议使用异丙醇来清洁 LED，如果要采用其他溶剂清洁，一定要确保此溶剂不会对环氧、有机硅、硅胶、支架镀银层等产生影响。不建议使用超声波清洗以免对 LED 造成损伤。若不可避免，清洗前请事先进行预测试，以确认是否对 LED 造成不良影响或潜在性隐患。

8、Other caution：

- 8.1、White LEDs are devices which are packaged by combining Blue LEDs and special phosphors. Consequently, the color of the LEDs is slightly changed with different driving current. Care should be taken when using LEDs
- 8.2、Anti radioactive ray design is not considered for the products listed here in.
- 8.3、Gallium Arsenide is used in some of the products listed in this publication. These products are dangerous if they are burned or shredded in the process of disposal. It is also dangerous to drink the liquid or inhale the gas generated by such products when chemically disposed.
- 8.4、Long time exposure of sunlight or occasional UV exposure will cause lens discoloration.
- 8.5、LED electrode and lead frame are comprised of a silver plated copper alloy. The silver surface may be affected by environments which contain corrosive gases and so on. Please avoid conditions which may cause the LED to corrode, tarnish or discolor. This corrosion or discoloration might lower solder ability or might affect on optical characteristics.
- 8.6、Please do not recommend to cover the silicone resin of the LEDs with other resin (epoxy, urethane, etc)
- 8.7、When populating boards in SMT production, there are basically no restrictions regarding the form of the pick and place nozzle, except that mechanical pressure on the surface of the resin must be prevent.
- 8.8、Please be aware that this product should not come into contact with other parts in assembled status.
- 8.9、Please design a circuit that prevents any reverse voltage (excess current) from being applied to this product instantaneously when the circuit is ON or OFF.
- 8.10、Surface of Lead frame is Ag-plated and elementary substance Ag easily react with sulphur and halogen material(F, CL,Br and I), which result in change of surface and color. So you have to keep LED away from those elementary substance listed above(may contained in accessories, raw material of driver and environmental materials) to avoid LED failure(Decay, color shift and failure)
- 8.11、Avoid touching silicone resin parts especially by sharp tools such as Pincette(Tweezers)
- 8.12、This product complies with RoHS directives.This product is intended for the application in general electronic devices (such as office automation equipment, communication devices, audio-video equipment, home electrical appliances, measurement hardware and others), especially in general lighting. In cases where this product is used for the applications that requires high reliability or could directly affect human life or health due to failure or malfunction (aerospace hardware, medical equipment, atomic control equipment and others), please consult with our sales representatives beforehand. Our warranty does not cover situations where this product undergoes secondary fabrication such as changes in shape.

8、其他注意事项：

- 8.1、白光 LED 是由蓝光芯片和特种荧光粉组合。因此，LED 的发光颜色会随着工作电流的变化而变化，使用前应考虑此因素是否能达到预期效果。
- 8.2、产品的应用可不用考虑防辐射的设计。
- 8.3、砷化镓应用在某些发射管上，这类产品在废弃处理过程中禁止碎化或燃烧以免引起危害。由此类产品在废弃处理过程产生的气体或液体，吸入或饮用亦是危险的。
- 8.4、LED 长时间暴露在阳光或偶尔暴露在紫外线下可能导致胶体或透镜黄变。
- 8.5、为保证 LED 光电性能，请保持 LED 发光区域表面清洁，避免手指印或其它异物覆盖。
- 8.6、不建议在 LED 的硅胶表面覆盖其他与之不兼容的脂类物质。
- 8.7、鉴于吸嘴的形式，除了要避免作用在硅胶表面的机械外力，对 SMT 贴装制程基本无限制。

- 8.8、请留意避免 LED 在组装时与其他组件发生干涉现象。
- 8.9、在设计电路时应预防开关过程中产生逆向电压或过大电流对 LED 的瞬间冲击。
- 8.10、LED 支架表面处理采用镀银工艺，单质银易与硫、卤素（氟、氯、溴、碘）等元素发生反应，导致 LED 外观及光色发生变化。故请客户在组装及应用过程需排除上述元素（含灯具、电源原材料，车间生产环境等），避免上述元素与 LED 镀银层发生反应致 LED 失效（光衰、色温漂移、死灯等）。
- 8.11、使用过程中避免镊子等锋利工具触碰硅胶胶体部分。
- 8.12、产品符合 RoHS 指令，产品意图主要应用在通用电气设备（如办公自动设备、通讯设备、视听设备、家用电器、测量工具等）特别是通用照明。一旦应用在高可靠度或由于故障失效而直接影响人身安全等领域产品上（航空产品、医疗设备、自动控制系统等），请事先联系我们的销售代表。

Runlite/源磊		Customer/客户	
Prepared/制作	梁国军	Engineering/工程	
Checked/审核		Quality/品质	
Approved/批准		Approved/批准	